

COMMON

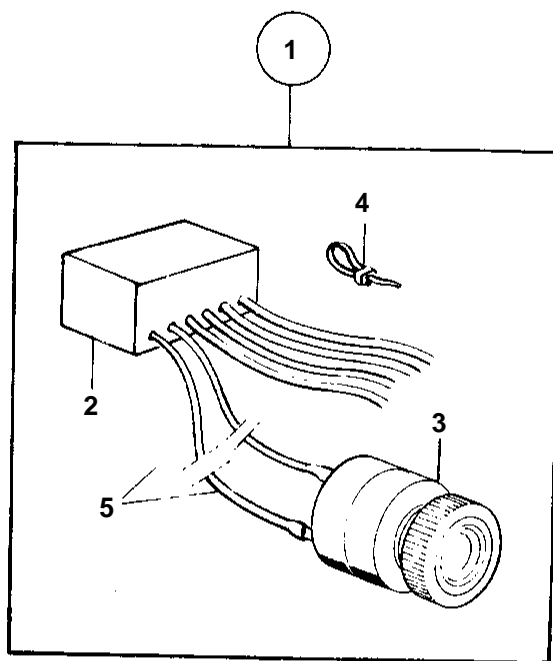

30 24

COMMON

REF	PART NO.	QTY	DESCRIPTION	NOTES
1	827940	1	Alarm kit	12V
2	831625	1	• Thermo monitor	12V
3	827597	1	• Horn unit	
4	948210	2	• Strip clamp	(827353)
5		X	• CABLES AND TERMINALS	SEE GROUP 3